

- Montage auf Gipskartonplatten
- Keine Kollision mit der Deckenkonstruktion
- Lichtlinie bündig mit der Oberfläche
- Unsichtbare Aluminiumelemente

### ZWECK DES PRODUKTS

- Hauptbeleuchtung und dekorative Beleuchtung

### INSTALLATION

- im Gipskartonplatten, mit Montageklebern
- kann einfach zu Strängen verbunden werden

### ZUSÄTZLICHE INFORMATION

- um die Leuchte während des Einbaus zu schützen, sollte eine Schutzeinlage TECH-KA verwendet werden

### TECHNISCHE ZEICHNUNG

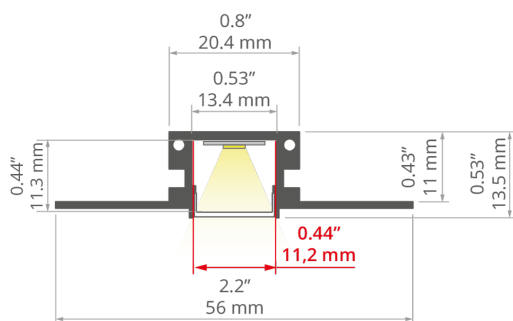

### TECHNISCHE SPEZIFIKATIONEN

Material	Aluminium	Länge		Ref	
Farbe	■ silbern Nicht eloxiert	1000 mm		18040NA_1	
Versiegelbar bis IP	20, 67	2005 mm		18040NA_2	
Mögliche Formen der Leuchte	polygonal	3010 mm		18040NA_3	
LED-Klebebreite A	11 mm				
Anzahl LED-Streifen A (8 mm breit)	1				
Breite	56 mm				
Abdeckung zugeschnitten auf die Profillänge	ja				
Möglichkeit der einfachen Verbindung zu Strängen	ja				
Hauptbeleuchtung	ja				
Dekorative Beleuchtung	ja				
Für GK-Platten	ja				

Zur Deckung mit Feinputz ja

Kabelführung von unten ja

## BEISPIELPROJEKTE



## ABDECKUNGEN

NAME	MATERIAL	LICHTDURCHLÄSSIGKEIT	FARBE	REF.
KA		PC	<input type="checkbox"/> milchige	17035
			<input checked="" type="checkbox"/> transparente	17036
KA-PRO		PC	<input type="checkbox"/> milchige	17064
			<input checked="" type="checkbox"/> transparente	17065
HS		PC	<input type="checkbox"/> milchige	1369
			<input checked="" type="checkbox"/> transparente	1370
KA-COM		PVC	<input type="checkbox"/> milchige	17121
			<input checked="" type="checkbox"/> transparente	17122
LIGER		PC	<input type="checkbox"/> milchige	17037
				17037OP
32	<input checked="" type="checkbox"/> grau			17040

## ENDKAPPEN

NAME	MATERIAL	FARBE	REF.
KOZMA	PP	<input checked="" type="checkbox"/> grau	24217

## LED



**K-1210-12V**  
K-1210-12V

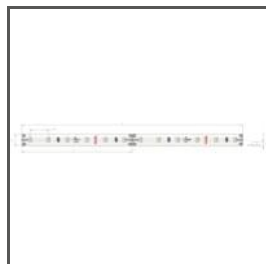

**K-1210-24V**  
K-1210-24V



**K-1220-12V**  
K-1220-12V



**K-1220-24V**  
K-1220-24V



**K-1275-12V**  
K-1275-12V



**K-1275-24V**  
K-1275-24V

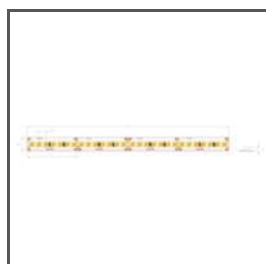

**K-1820-HD-24V**  
K-1820-HD-24V

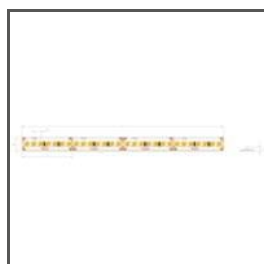

**K-1910-HD-24V**  
K-1910-HD-24V



**WP-K-1640-HD-IP65-24V**  
WP-K-1640-HD-IP65-24V

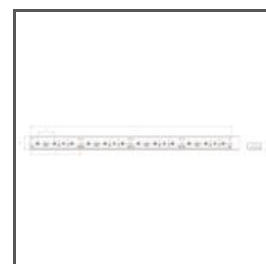

**WP-K-1210-12V**  
WP-K-1210-12V

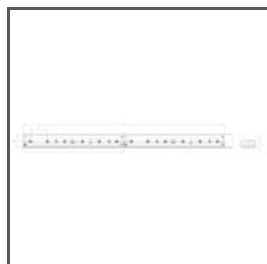

**WP-K-1210-24V**  
WP-K-1210-24V



**WP-K-1220-12V**  
WP-K-1220-12V



**WP-K-1220-24V**  
WP-K-1220-24V

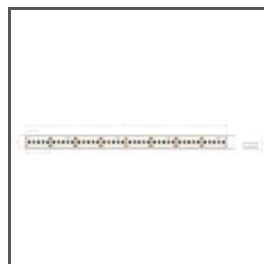

**WP-K-1275-12V**  
WP-K-1275-12V



**WP-K-1275-24V**  
WP-K-1275-24V



**WP-K-1910-HD-IP65-24V**  
WP-K-1910-HD-IP65-24V



**WP-K-1220-IP65-12V**  
WP-K-1220-IP65-12V



**WP-K-1220-IP65-24V**  
WP-K-1220-IP65-24V

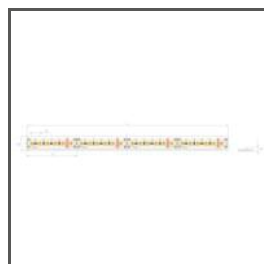

**K-LR-1000-24V**  
K-LR-1000-24V



**K-HE-0480-HD-24V**  
K-HE-0480-HD-24V

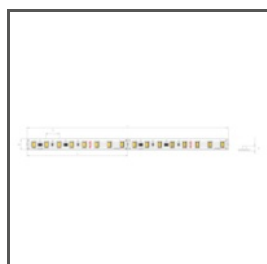

**K-HE-0960-HD-24V**  
K-HE-0960-HD-24V

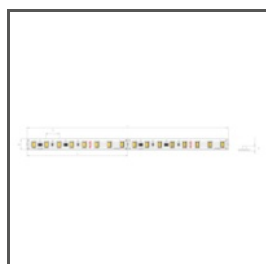

**K-HE-1440-HD-24V**  
K-HE-1440-HD-24V

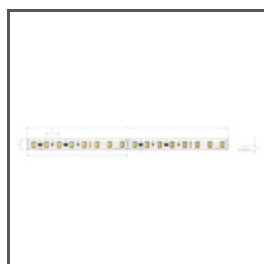

**K-HE-1920-HD-24V**  
K-HE-1920-HD-24V

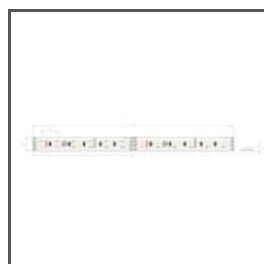

**K-1275-RGB-24V**  
K-1275-RGB-24V

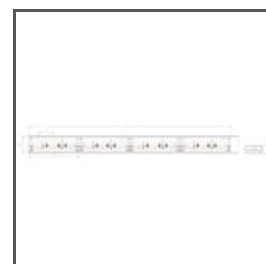

**WP-K-1275-RGB-12V**  
WP-K-1275-RGB-12V



**K-1530-RGB+W-24V**  
K-1530-RGB+W-24V



**K-1920-120-RGB-24V**  
K-1920-120-RGB-24V

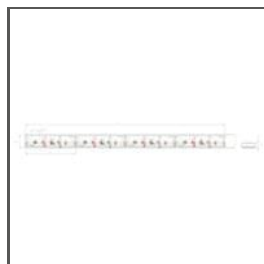

**WP-K-1920-120-RGB-24V**  
WP-K-1920-120-RGB-24V

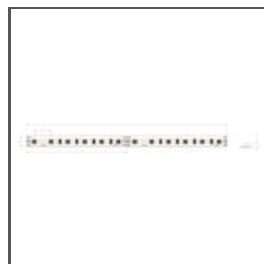

**K-27/65-1920-24V**  
K-27/65-1920-24V

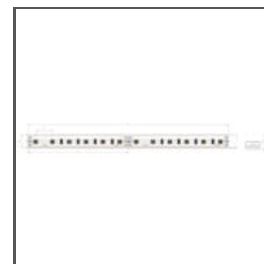

**WP-K-27/65-1920-24V**  
WP-K-27/65-1920-24V

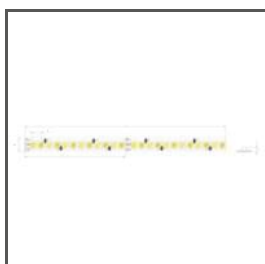

**K-22/50-1728-24V**  
K-22/50-1728-24V

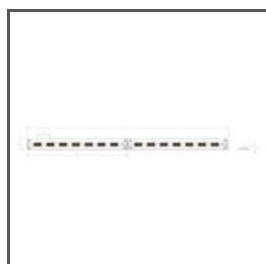

**K-30/18-1770-24V**  
K-30/18-1770-24V

## ANDERE



VERBINDUNGSSTÜCK  
**ZM-NA-90**  
42723



VERBINDUNGSSTÜCK  
**ZM-NA-120**  
42729



VERBINDUNGSSTÜCK  
**ZM-NA-135**  
42725



VERBINDUNGSSTÜCK  
**ZM-NA-PION-135**  
42727

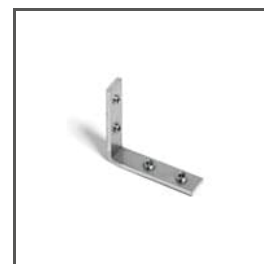

VERBINDUNGSSTÜCK  
**ZM-NA-PION-90**  
42726

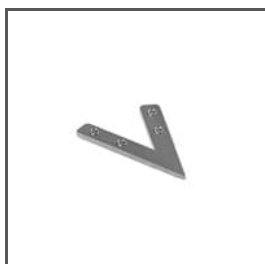

VERBINDUNGSSTÜCK  
**ZM-NA-45**  
42339



VERBINDUNGSSTÜCK  
**ZM-NA-PION-120**  
42321

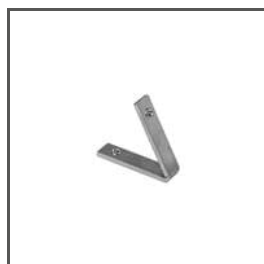

VERBINDUNGSSTÜCK  
**ZM-NA-PION-60**  
42317



VERBINDUNGSSTÜCK  
**ZM-NA-PION-45**  
42315



VERBINDUNGSSTÜCK  
**ZM-NA-180**  
42724

# Profil KOZMA

Ref. 18040



KABELVERSCHRAUBUNG

**6x1,2**  
00802

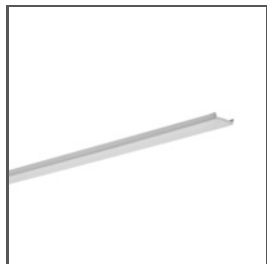

SCHUTZEINLAGE

**TECH-KA**  
17123



VERBINDUNGSSTÜCK

**ZM-60**  
42736